

## M SERIES BLOWER MODULE – 60 Hz

### Model Number

M 2430 B L 1 - STD X  
 ① ② ③ ④ ⑤ ⑥ ⑦

- |   |   |
|---|---|
| <p>① <b>Unit Type</b><br/>M=Modular</p> <p>② <b>Nominal Capacity</b><br/>2430=24000 to 30000 Btu/hr<br/>(7.0 to 8.8 kW)<br/>3642=36000 to 42000 Btu/hr<br/>(10.5 to 12.3 kW)<br/>4860=48000 to 60000 Btu/hr<br/>(14.0 to 17.5 kW)</p> <p>③ <b>Module Type</b><br/>B=Blower Module</p> | <p>④ <b>Configuration</b><br/>L=Left-hand connection</p> <p>⑤ <b>Revision</b><br/>1, 2, 3, etc.</p> <p>⑥ <b>Power Supply, Motor Type</b><br/>STD=1/60/208-240, single-speed<br/>ACB=1/60/208-240, two-speed<br/>EC1=1/60/120, variable-speed<br/>EC2=1/50-60/240, variable-speed</p> <p>⑦ <b>Painted</b><br/>(blank)=none<br/>1=White</p> |
|---|---|



Typical Blower Module with cutaway revealing motor (-STD Model)

Table 1. Cross-reference to old models numbers

Model Number		Controls Option
New	Old	Description
MxxxxBL1-STD	MBxxxxL	Single speed motor with variable low speed controller
MxxxxBL1-ACB	MBxxxxL+CB	Two-speed motor with advanced control board
MxxxxBL1-EC1	n/a	Variable speed EC motor with S.M.A.R.T. control board, 120V
MxxxxBL1-EC2	n/a	Variable speed EC motor with S.M.A.R.T. control board, 240V

ACB (Advanced Control Board) – is an upgraded version of our standard model. It includes a high efficiency two-speed motor with soft-start and soft-stop for even quieter operation and configurable for almost every type of system. The two-speed motor provides a highly efficient ventilation speed mode but is not adjustable.

EC1/EC2– is part of the Unico Green Series. This control box includes a super efficient variable speed EC motor with the Unico SCB (S.M.A.R.T. control board). The airflow is completely configurable using a PC.

### General Information

The Unico System patented<sup>#</sup> modular blowers are designed for use with the Unico System small-duct high-velocity (SDHV) system. The blowers exceed the U.S. Department of Energy requirements for SDHV systems requiring a minimum external static pressure of 1.2 inches of water (298 Pa) at the rated airflow when installed with the compatible Unico cooling module.

Table 2. Standard Modules

Blower Module	Matching Unit	
	Heating Module	Cooling Module
M2430BL	M2430HL-HW	M2430CL-(AC,HP,CW)
M3642BL	M3660HL-HW	M3642CL-(AC,HP,CW)
M4860BL		M4860CL-(AC,HP,CW)

Note: Model numbers listed above do not include the latest revision code.

The blower module comes with several different motor and control options as follows.

STD (standard model) – are the most economical and readily available. They include a single-speed motor with a variable speed controller to adjust the low air speed delivery.

### Typical Application

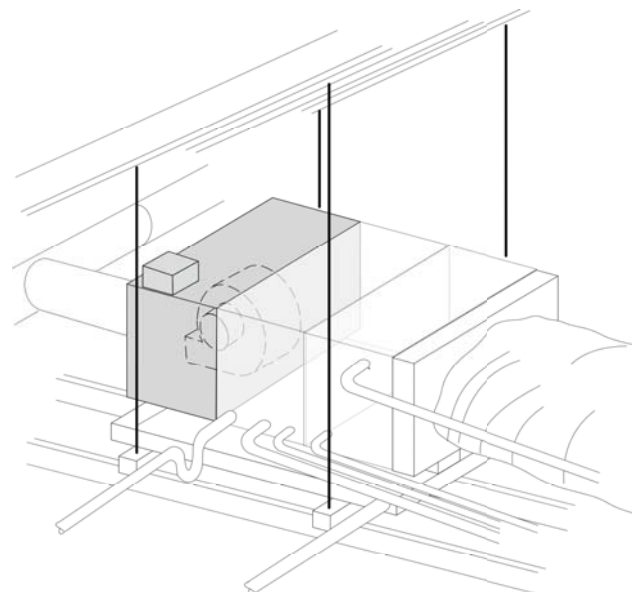

Attic Installation with Unico System Cooling Module, Heating Module, and Blower Module



CERTIFIED TO UL STD 1995  
 CONFORMS TO CAN/CSA STD C22.2  
 NO. 236

IL00022d cvs

### Cabinet Construction

The cabinet is fully insulated with closed cell insulation. There is no exposed fiberglass inside the cabinet. The cabinet is constructed of 22 gauge (0.7-mm) galvanized steel with removable access panels held on both sides for ease of service. All access panels are secured with slotted hex head washer screws and hardened steel U-clip nuts to prevent stripping. See Dimension drawing.

### Applications

For air-conditioning the rated airflow is 250 CFM per nominal\* ton (34 L/s per kW) and for heat pumps it is 275 CFM per nominal ton (37 L/s). For proper operation, we do not recommend less than 200 CFM per nominal ton (27 L/s per nominal kW). Refer to *Blower Performance Curves* later in this bulletin, for blower performance showing static pressure and amperage versus air flow.

### Features and Controls

The following table shows a comparison of the various features.

Control Box Configuration	STD	ACB	ECx
Balanced wheels	✓	✓	✓
Direct drive motor	✓	✓	✓
Shaft key connection	✓	✓	✓
Quick motor replacement (QMR)	✓	✓	✓
Separate control box	✓	✓	✓
Control voltage transformer	✓	✓	✓
Screw terminal connections	✓	✓	✓
Heat pump AFS bypass	**	✓	✓
Boiler relay		✓	✓
Number of modes of operation	2	2	6
Adjustable low airflow mode	✓		✓
Efficient ventilation mode		✓	✓
Adjustable restrictor plate	✓	✓	
Point-to-point wiring		✓	✓
Electric heater fan interlock		✓	✓
Electric heater stage 3 lockout protection		✓	✓
Chilled water relay		✓	✓
Air cycle feature		✓	✓
EAC, HRV, or ERV relay		✓	✓
Potable water circulation		✓	✓
Humidifier compatibility		✓	✓
UniChiller Leader/Follower control		✓	✓
Soft-start and Soft-stop		✓	✓
Constant airflow		✓	✓
Low airflow indicator			✓
Preset airflow settings			✓
Laptop configurable			✓
Laptop troubleshooting			✓
Optimized for zone damper systems			✓
Optimized for efficiency and sound			✓

\*\* with separate relay included in cooling module

**Balanced wheels** – All blower wheels are individually balanced.

**Direct drive motor** – The wheel is mounted directly to the motor shaft to improve drive efficiency and lower costs.

**Shaft key** – The wheel is attached to the motor shaft using a square keyway which is more secure than a simple set screws.

**Quick motor replacement (QMR)** – The QMR feature is a quick twist-and-lock motor mount for easy maintenance. The motor is mounted to the inlet ring which is attached to the blower housing with six screws through twist-lock keyholes. When service is required to the motor or the wheel, the entire assembly may be removed as a whole. See Figure 1.

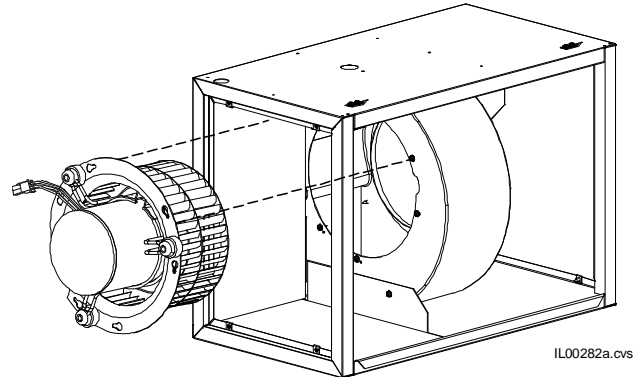

Figure 1. Quick motor replacement (QMR) feature

**Separate control box** – The control box is separate from the cabinet (ships loose) so that it may be mounted to the top or front of the cabinet, depending on which is more convenient. Knockout and starter holes for the screws are provided to assist in mounting. All control boxes include the following features:

**Control voltage transformer** – a 50VA 24-volt transformer which provides control voltage power to the thermostat, electric heaters, and other optional equipment.

**Screw terminal connections** – terminal blocks with large screws and wire washers to securely connect the control wires.

**Heat pump AFS bypass** – removes the anti-frost switch (AFS) from the circuit during heat pump heating mode which eliminates nuisance shutdowns during defrost mode.

**Boiler relay (ACB, EC)** – The ACB and SCB includes a separate dry-contact relay to turn on the boiler, boiler pump, or hot water coil valve. (The STD control box includes room for a relay to be added.)

**Modes of operation** – Both the STD and ACB controls allow for high and for low airflow modes. The EC control has 6 modes (FAN-ONLY, LOW-COOL, HIGH-COOL, LOW-HEAT, HIGH-HEAT, and EMERGENCY HEAT). The STD control allows the user to *adjust the low airflow* amount but is not very efficient. The EC control allows adjustability for every mode maintaining high efficiency. The ACB cannot be adjusted but provides *high efficiency ventilation*.

**Adjustable restrictor plate (STD, ACB models only)** – The patented restrictor plate provides a low cost solution to finely adjust the airflow using a single or two-speed motor. The movable restrictor plate is accessible from the

exterior of the front of the unit even with the duct installed.

*Point-to-point wiring (ACB and EC)* – The control boards have separate terminals for the thermostat, electric heater, outdoor condenser, and other options for easy wiring and troubleshooting.

*Electric heater stage 3 lockout (ACB and EC)* – The control board includes a lockout feature to prevent the third stage of the electric heater from turning on if the heat pump is also on. This prevents nuisance shutdowns from overheating the electric heater. This feature is available with the STD control box by using an outside thermostat.

*Chiller relay (ACB and EC)* – The control box includes a separate dry-contact relay (ColdW) to turn on a chiller or zone pump.

*Air cycle (ACB and EC)* – The control board includes a separate switch to provide periodic cycling of the fan to reduce the chance for water to collect in the ducts if located in a cold space and not used, or to provide periodic fresh air if connected to a fresh air source.

*EAC, ERV, or HRV (ACB and EC)* – For the optimum in indoor equality, the control board includes a dry-contact relay to turn on an electronic air cleaner, energy recovery ventilator, or heat recovery ventilator any time the fan is on.

*Potable water circulation (ACB and EC)* – For improved health safety, the control provides a switch selectable feature to turn on the boiler pump periodically if installed as part of a domestic water system to prevent the formation of stagnant water.

*Humidifier compatibility (ACB and EC)* – The control board includes the ability to connect a humidistat and a humidifier so that the humidistat turns on the humidifier when needed. The user may choose whether the fan with humidifier operates at high or low HEAT airflow setting.

*UniChiller Leader/Follower control (ACB and EC)* – The control allows one air handler to be set the UniChiller mode of operation as the ‘Leader’ with all other air handlers dependent (‘Follower’).

*Soft-start and soft-stop (ACB and EC)* – For quieter operation, the unit will slowly ramp the motor from stop to full speed, and vice versa.

*Constant airflow (EC only)* – The EC control will deliver the airflow requested without any user adjustments to the duct system, or requiring the user to measure the amperage.

*Low airflow indicator (EC only)* – The S.M.A.R.T. control board (SCB) includes an indicator light that informs the user that the desired airflow is not being met, usually caused by a restrictive duct system or too few outlets.

*Pre-set air flow rate (EC only)* – The SCB is pre-programmed for two different air flow rates for HIGH-COOL that can be selected with a board mounted switch. Each of the six different modes are a fixed percentage of this airflow.

*Laptop adjustable (EC only)* – The airflow for each mode of operation is adjustable to any value between the blower minimum and maximum using the ECMconfig software (available for download at [www.unicosystem.com](http://www.unicosystem.com)) and an ordinary USB cable.

*Laptop troubleshooting (EC only)* – The ECMconfig software will also provide the user with feedback indicating the actual airflow, motor speed, communications between the boards and the motor, and the state of various inputs and outputs.

*Optimized for zoning with hydronic systems (EC only)* – The ECMconfig software provides an additional feature that allows the user to specify the maximum motor speed so that the motor does not over speed when zone dampers are closed. This prevents the need for bypass loops and pressure switch controls and reduces noise at the outlets caused by the blower trying to maintain a constant airflow with fewer outlets. This feature should not be used for refrigerant cooling coils.

#### **CAUTION.**

**To prevent coil frosting with refrigerant cooling coils, do not operate with less than 200 CFM per nominal ton (26.8 L/s per kW).**

*Optimized for efficiency and sound (EC only)* – The EC control will use the lowest motor speed to achieve the required airflow, which minimizes sound and maximizes electrical efficiency.

**Blower Module Specifications – 60 Hz**

Model No.		M2430B-	M3642BL	M4860BL
Electrical Characteristics		208 – 230 Volts / 60 / 1 phase		
Motor Size, HP (kW)		1/2 (0.37)	1 (0.75)	
Motor Type	-STD, -ACB	PSC		
	-SCB	EC (variable speed)		
Motor Capacitor, mfd.	-STD, -ACB	10		
Motor Capacitor, mfd.	-SCB	none		
Motor Full Load Amps	-STD	3.0	6.2	6.2
	-ACB	3.3	4.8	4.8
	-SCB	3.2	6.1	6.1
Motor Speed, RPM	-STD	1700		
	-ACB	1700/800		
	-SCB	400-1800		
Blower Wheel Nom. Diameter, in. (mm)		9.5 (241)		
Blower Wheel Width, inch (mm)		3.75 (95)	5.0 (127)	7.75 (197)
*Nominal Air Flow Rate, CFM (L/s)		600 (283)	900 (425)	1250 (590)
*Plenum Static Pressure, in. water (Pa)		1.5 (373)	1.5 (373)	1.5 (373)
Minimum Plenum Size, ID, inch (mm)		7 (178)	9 (229)	10 (254)
Sound Pressure Level	dB(A)	56	56	58
	NC	50	47	50
Shipping Weight, lb (kg)		62 (28)	72 (33)	72 (33)

\* based on full open restrictor and minimum plenum size at 230V.

**Measuring airflow.**

To determine the airflow when using the single or two-speed motors (-STD, -ACB models), measure the amperage and look up the airflow in the following table. This is not necessary for the variable speed motors because they are programmed to deliver the airflow that you need.

**Blower Performance (with cooling module installed) –STD and –ACB models**

External Static Pressure, in. water (Pa)	1.0 (250)		1.25 (310)		1.5 (370)		1.75 (435)		2.0 (500)	
	CFM (L/s)	Amps	CFM (L/s)	Amps	CFM (L/s)	Amps	CFM (L/s)	Amps	CFM (L/s)	Amps
<b>60 Hz – 230V</b>										
<b>STD models</b>										
<b>M2430LB</b>	870 (410)	3.1	810 (383)	2.9	740 (351)	2.7	660 (310)	2.4	510 (240)	2.0
<b>M3642LB</b>	1240 (585)	4.8	1170 (552)	4.5	1070 (505)	4.1	925 (437)	3.6	745 (352)	3.1
<b>M4860LB</b>	1472 (695)	4.7	1400 (660)	4.5	1300 (610)	4.2	1162 (548)	3.9	953 (450)	3.4
<b>ACB models</b>										
<b>M2430LB+ACB</b>	760 (360)	2.3	700 (330)	2.1	640 (302)	2.0	550 (260)	1.7	450 (212)	1.5
<b>M3642LB+ACB</b>	1380 (617)	5.2	1300 (613)	4.9	1200 (566)	4.5	1090 (514)	4.0	950 (448)	3.6
<b>M4860LB+ACB</b>	1480 (698)	5.0	1430 (674)	4.4	1360 (642)	4.5	1220 (575)	4.0	930 (439)	3.1

## Dimensional Data

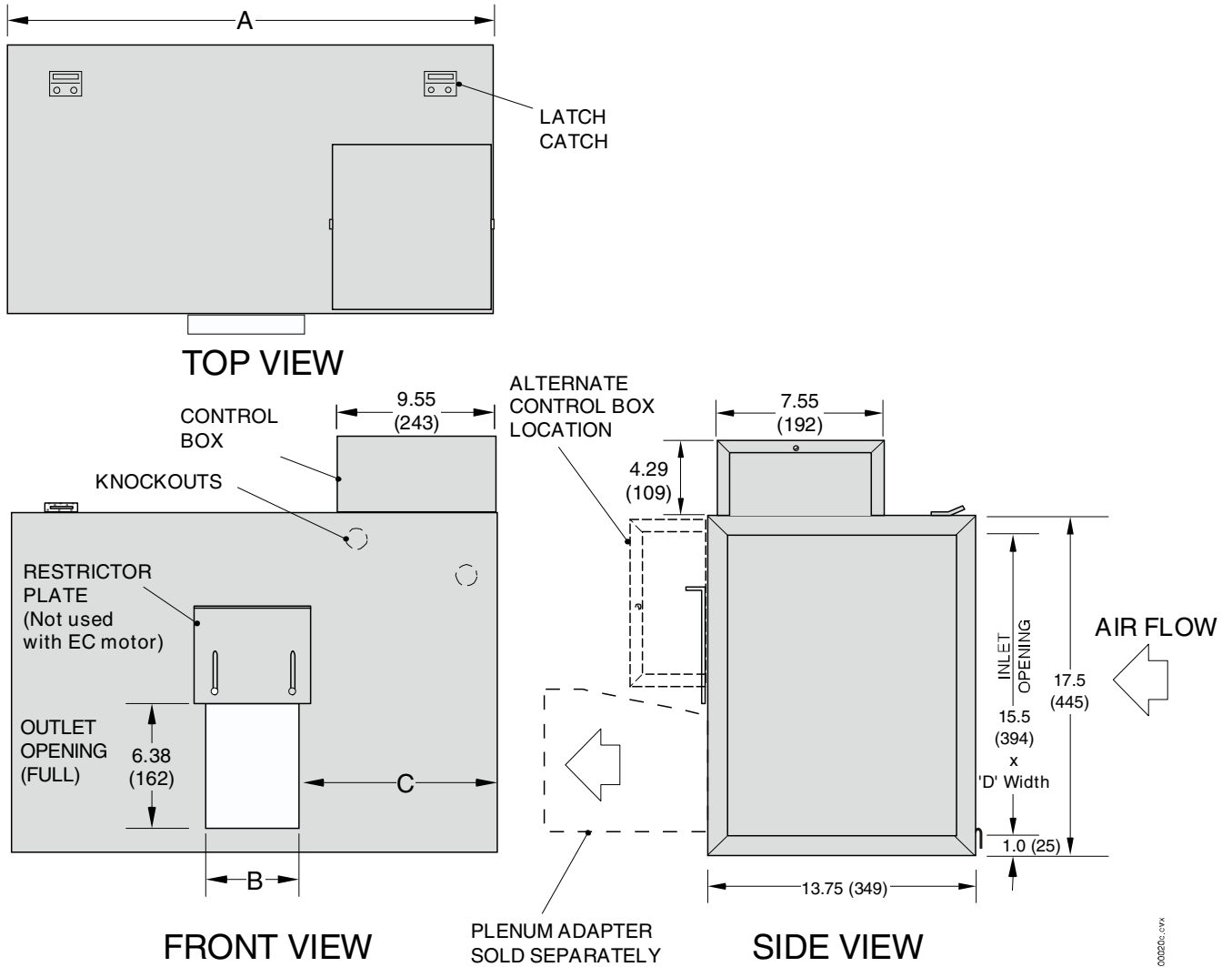

IL00020c.cvx

ALL DIMENSIONS IN inches (mm)

Model No.		M2430BL	M3642BL	M4860BL
Dimensions, in. (mm)	A	25 (635)	38 (965)	
	B	6.00 (152)	7.16 (182)	9.92 (252)
	C	9.50 (242)	15.4 (392)	14.0 (356)
	D	23 (584)	36 (914)	

## Acoustical Data

Sound is always present in our lives and is important to comfort. Understanding how sound is defined is essential to understanding how to design a proper Unico System. Sound is defined as a physical disturbance in pressure that is detectable by the human ear. Sound is usually presented as Sound Pressure Level (SPL) in decibels (dB), but can also be presented as Sound Power Level (SWL). Sound pressure is what you hear so it is the only value that is important to the occupant. However, determining the value is difficult because it is dependent on the surroundings and distance from the sound source. For instance, a carpeted room is much quieter than a room with wood floors.

For the Unico System, it is also important to consider sound transmission losses through ceilings and walls. The blower is never placed in the occupied room so the sound is always less than the published value. This reduction in sound level depends on the construction of the ceiling or wall. For instance, a ceiling structure made of gypsum board with insulation above it will have a much greater sound transmission loss (TL) than a dropped ceiling without insulation.

The data shown in this catalog was measured in a large room with hard surfaces for the walls and floor. It is considered to be the worst case (i.e. loudest) situation. The sound level in the occupied space will always be considerably less than this, depending on where the unit is located. To determine the actual sound level, subtract the TL for the barrier from the sound data of the unit. The table below shows typical TL values for common construction configurations. Subtract these values from the Unico air handler data.

Transmission Loss for Common Construction, dB

Frequency, Hz	125	250	500	1k	2k	4k	R
Sheet Metal, 24 ga	13	17	20	27	34	39	18
Ceiling Tile, mineral fiber	13	21	27	31	35	40	20
Gypsum Frame wall	12	23	31	38	42	37	20
Gypsum Frame wall, insul.	15	30	32	43	46	38	23
Wood Floor, uninsulated	22	28	37	43	46	43	25
Wood Floor, insulated	29	40	51	57	60	58	26
Concrete Block, 190-mm	38	41	43	50	55	61	26
Concrete, 100-mm (4 in.)	41	41	45	52	56	64	26

Ref: Handbook of Acoustical Measurements and Noise Control, 1998  
 R = Overall Loss for typical Blower Module

Both the -STD and -ACB models include a patented restrictor plate to fine tune the airflow amount which creates a small amount of turbulence and noise. This is only noticeable near the unit if the unit is installed close to the occupied space. The -EC models do not need a restrictor plate and, thus, can be as much as 3-5 dB quieter if located near the occupied space.

Note: Using muffler on the discharge of the unit will reduce the sound pressure by 3 dB. The muffler should be a metal duct with at least 1.5 inches (38 mm) of fiberglass insulation, measuring at least 10 D x 20 L inches (250 D x 500 L mm).

For example, if a M2430BL located above a dropped ceiling, the noise level in the room will be reduced 20 dB, from 56 to 36 dBA, making the Unico System one of the quietest systems on the market. Similarly, if the same unit is installed in an attic with insulation, the sound level will only be 29 dB in the room.

## Sound Pressure Levels (Lp)

The sound pressure level for each unit was measured in a reverberant room measuring approximately 21 x 35 ft (6.4 x 10.7 m) with hard tiled floors, hard walls, acoustical ceiling tiles, and no furniture. The sound level meter was located near the side of the unit as shown below.

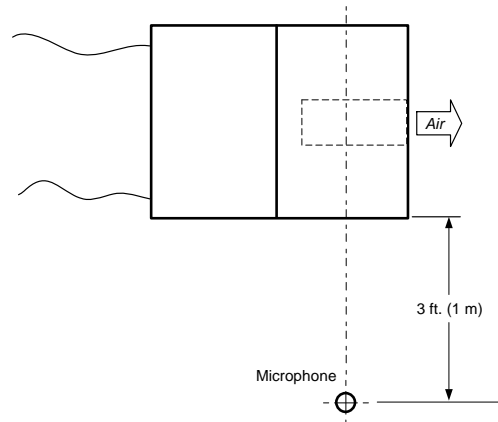

The data shown on the next page was measured at a motor speed of 1700 RPM at maximum airflow. It is considered the worst (loudest) condition. Using the EC motor with additional outlets will significantly reduce the radiated sound by reducing the needed static pressure and consequently the motor speed.

### Acoustical Data (max airflow at 1.5 inches static pressure)

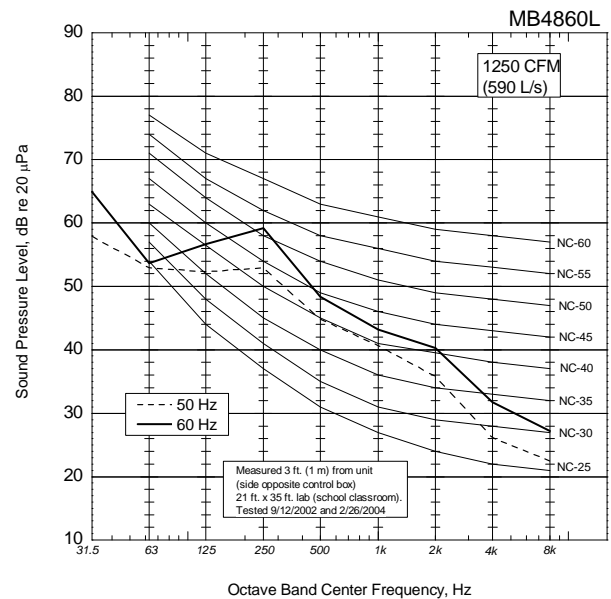
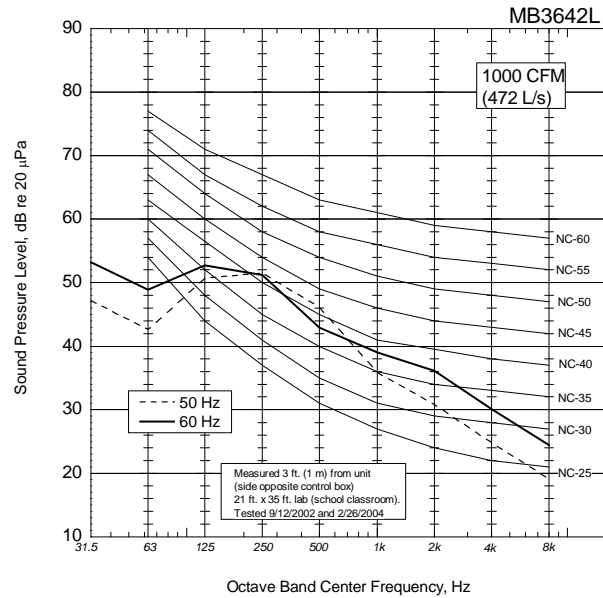
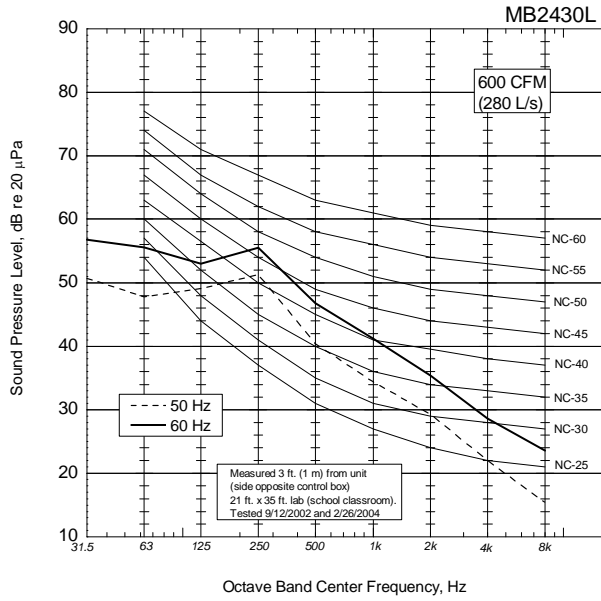

# Blower Capacity Data (-STD models)

## M2430BL-STD

60Hz

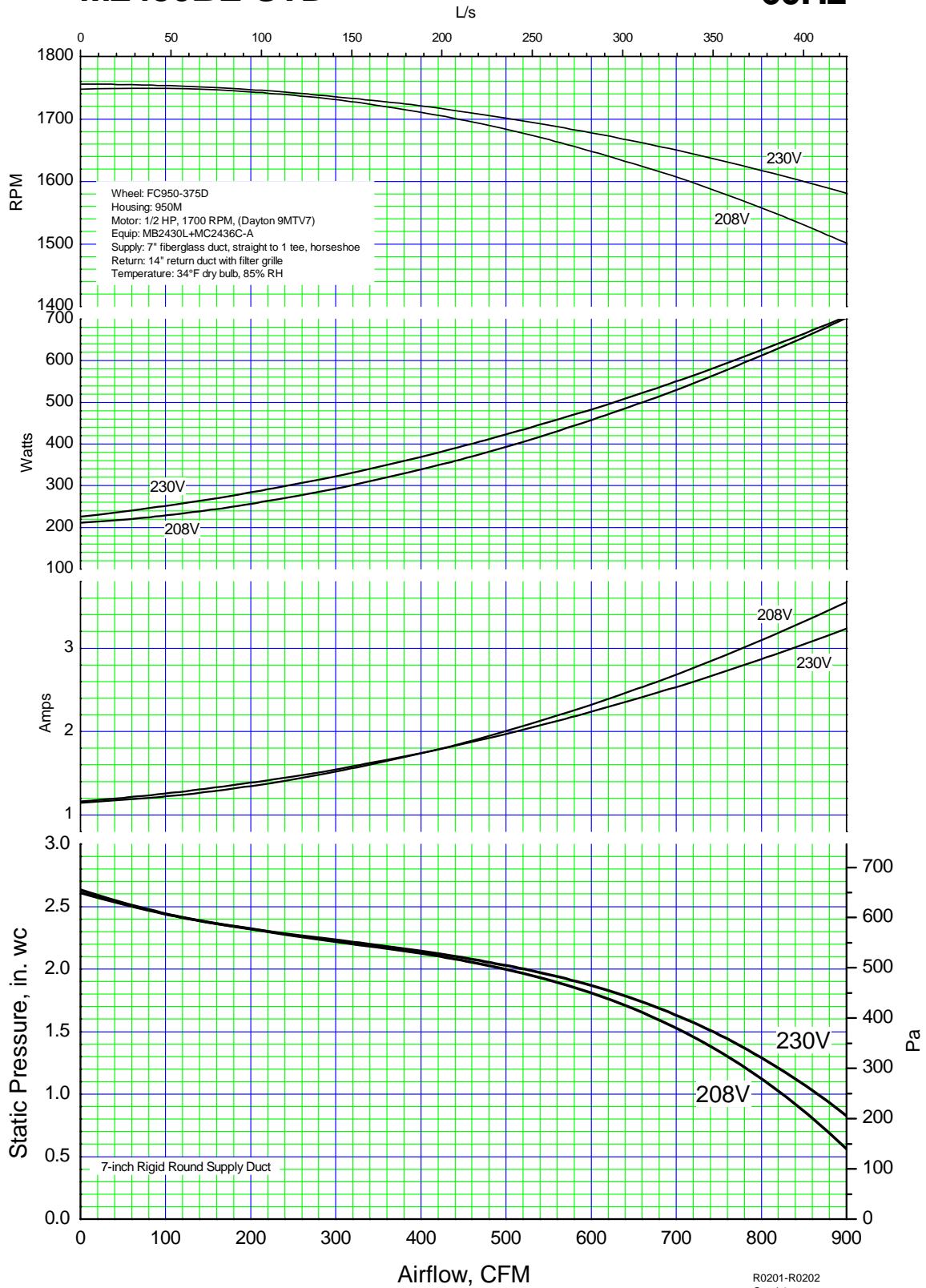

R0201-R0202  
 Graph1  
 01/24/2002  
 Tested by: Seden Kalyoncu  
 Approved by: C. Messmer



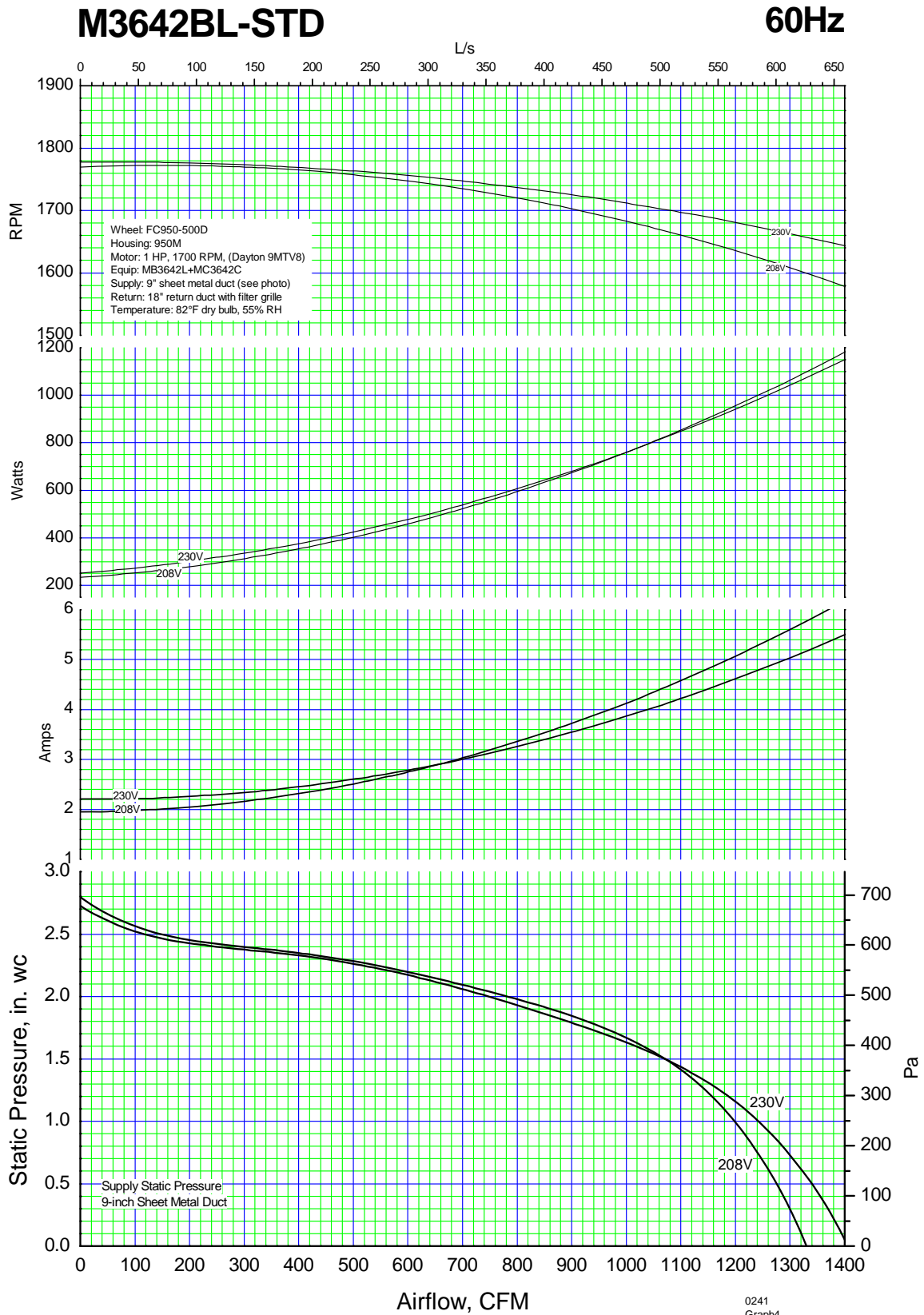

0241  
 Graph4  
 09/18/2002  
 Tested by: J.Riley  
 Approved by: C. Messmer

# M4860BL-STD

60Hz

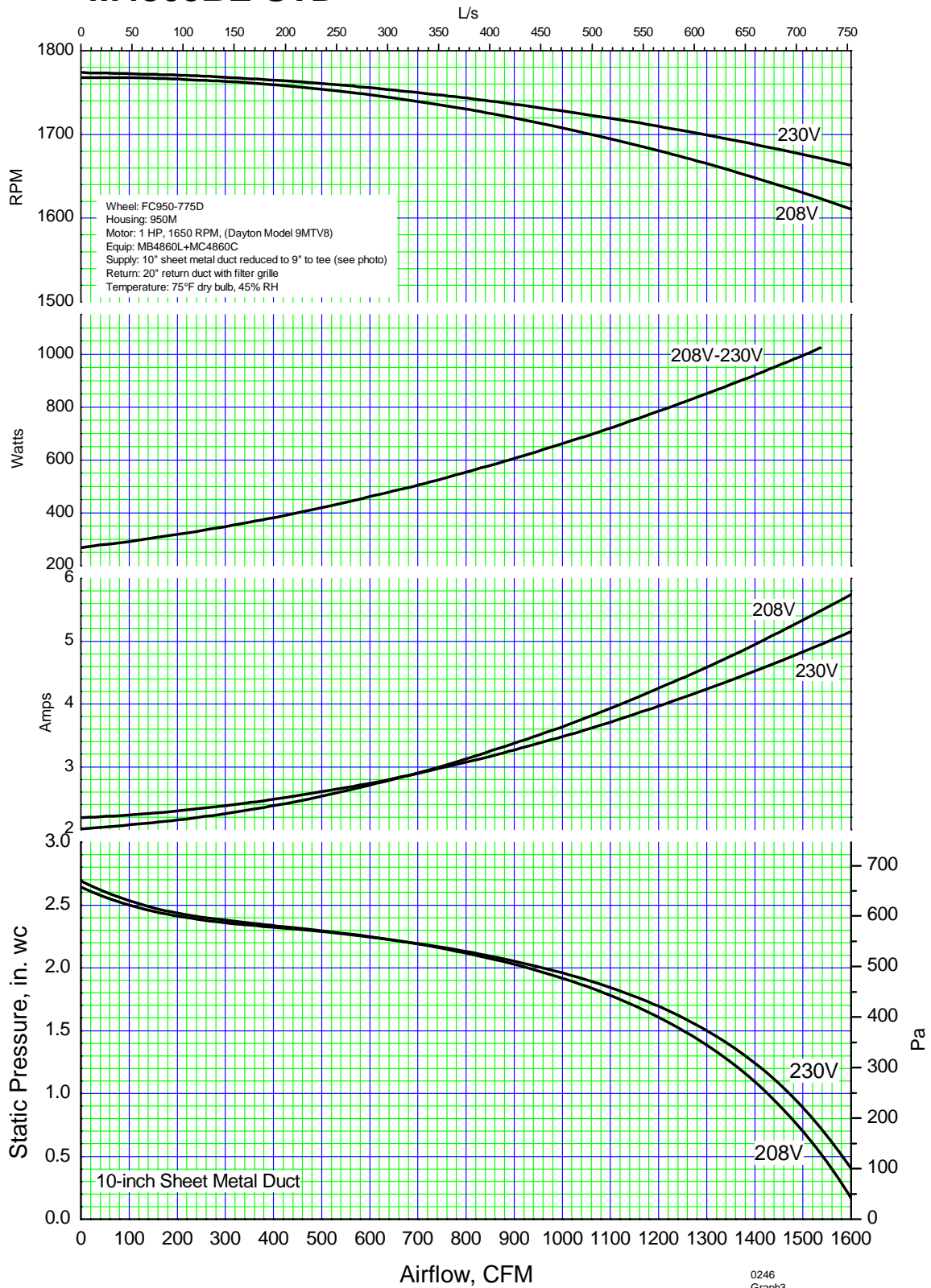

0246  
 Graph3  
 09/30/2002  
 Tested by: J.Riley  
 Approved by: C. Messmer

# Blower Capacity Data (-ACB models)

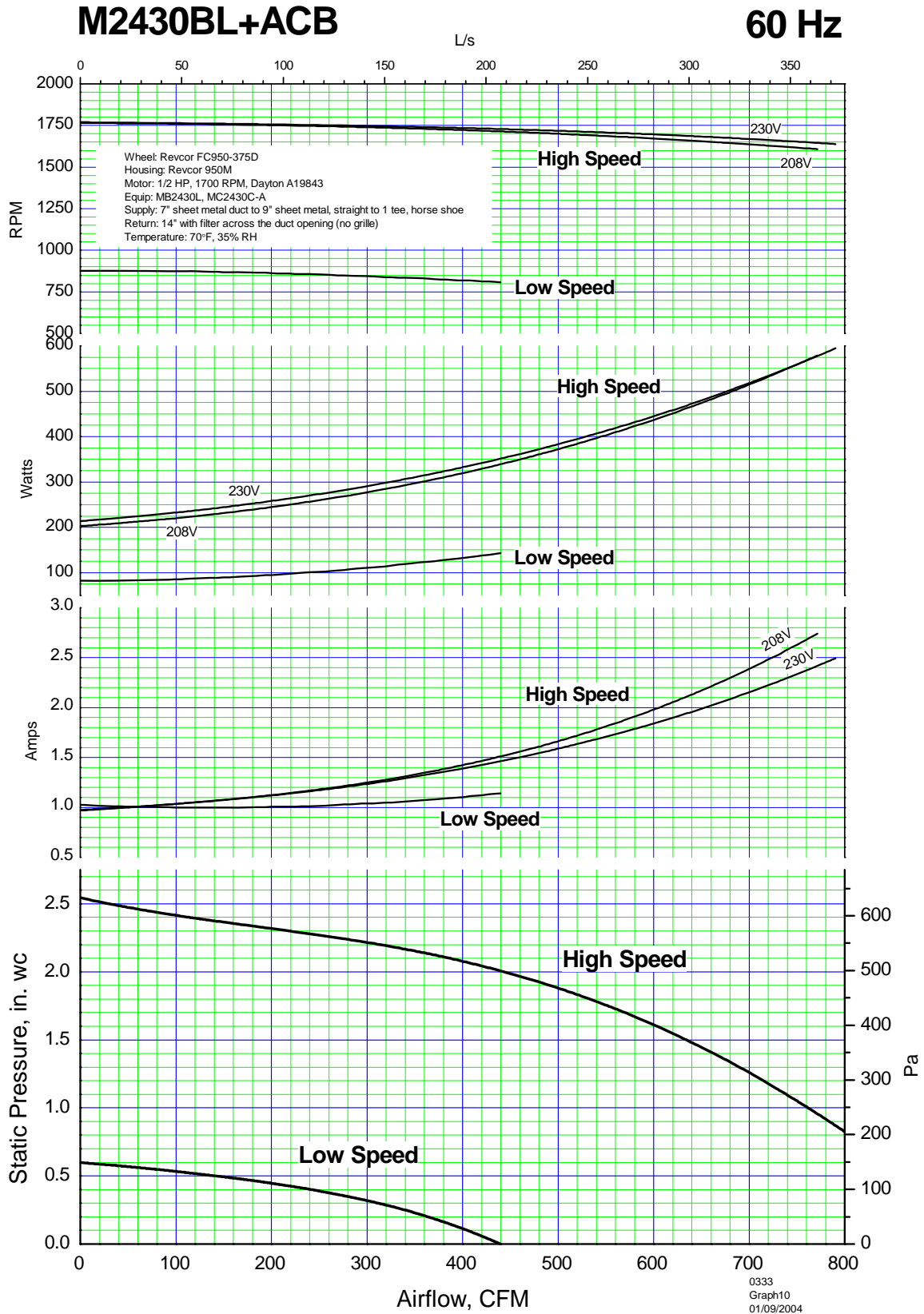

0333  
 Graph10  
 01/09/2004  
 Tested by: J. Riley  
 Approved by: C. Messmer



# M4860BL+ACB

## 60 Hz

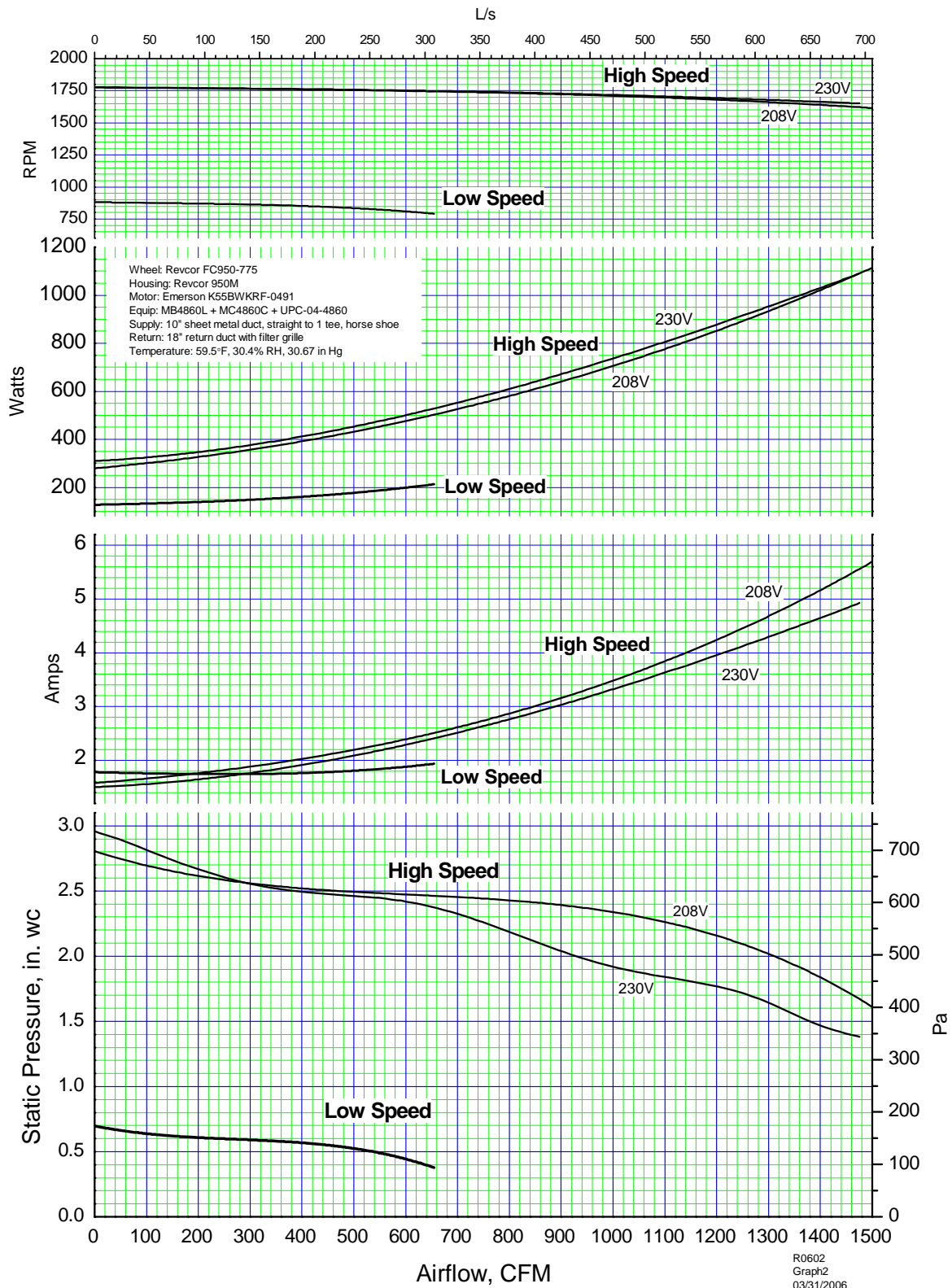

R0602  
 Graph2  
 03/31/2006  
 Tested by: E. Shapiro  
 Approved by: C. Messmer

# Blower Capacity Data (-EC models)

M2430BL1-EC1,EC2

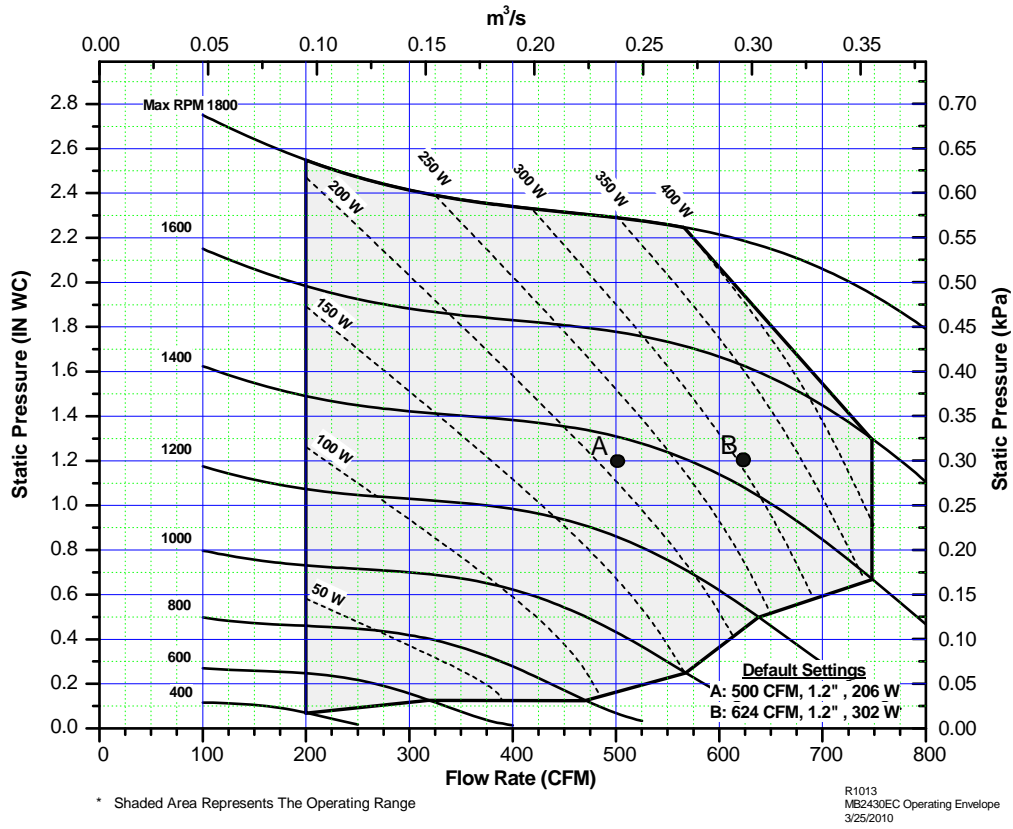

M3642BL1-EC1,EC2

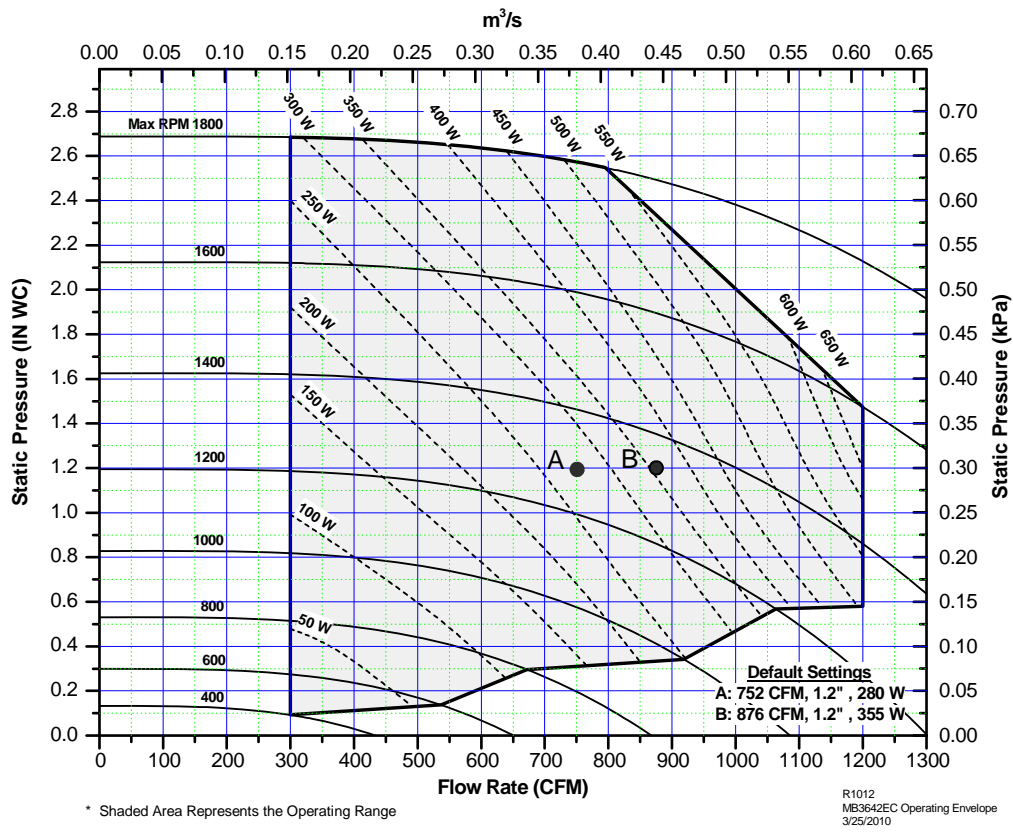

M4860BL1-EC1,EC2

